

## OPERATING UNIT

# LUNAR

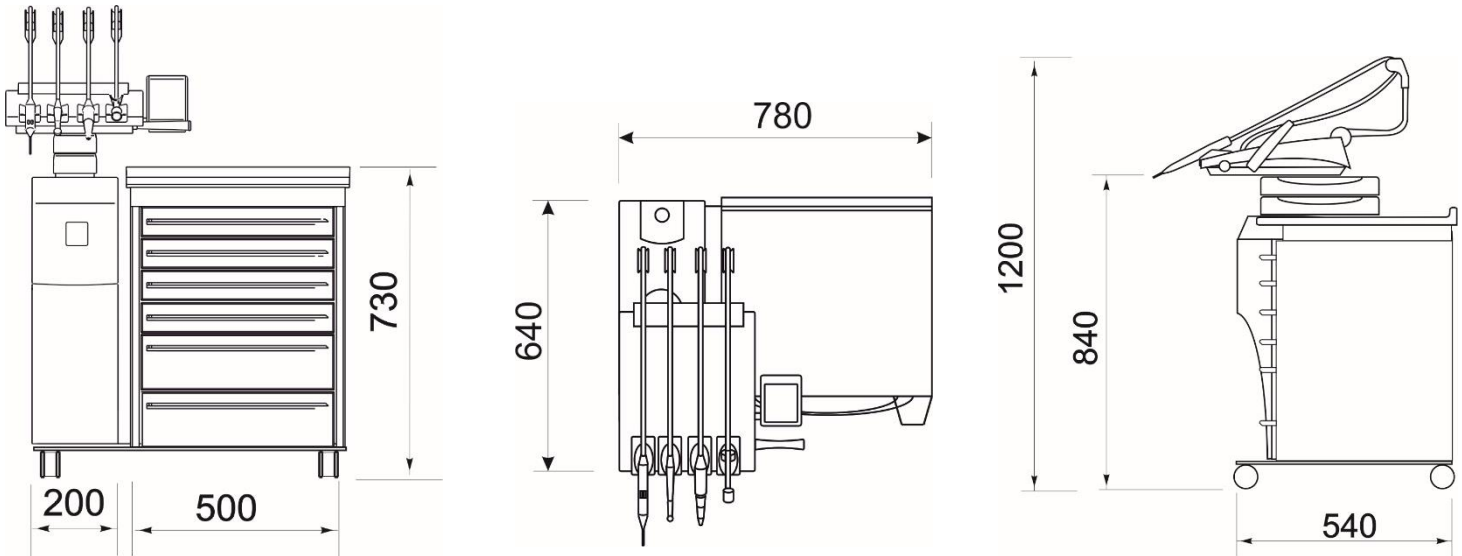

### Technical characteristics

- Operating voltage: 24 V
- Air: 5 bar, 50 l/min
- Power supply: 230 v/115 v, 250 W
- Weight: 90 Kg

### CHEST OF DRAWERS' CONFIGURATION



#### WITHOUT HANDLES

Drawers mounted on "push" slides that allow the opening of the drawer with a slight pressure on the front panel.



#### WHITE HANDLES

Drawers mounted on soft closing slides and equipped with a newly designed aluminum handle painted in white.



#### COLORED HANDLES

Drawers mounted on soft closing slides and equipped with a new design aluminum handle painted in a color of your choice from Stern Podia selection.

### TYPE OF DRAWERS (T1/T2/T3) AND DOORS (T5/T8):

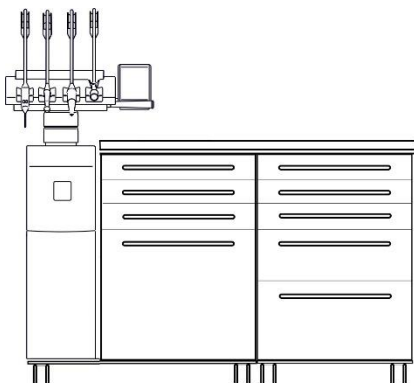
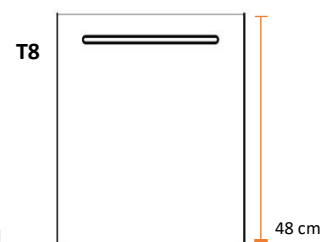
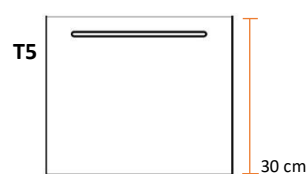
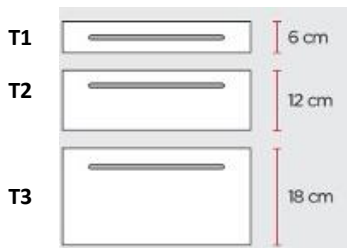



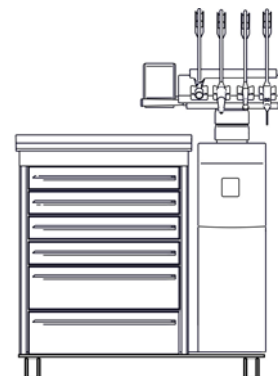







Possibility to configure the podiatric unit with an additional chest of drawers.



Possibility to order the Lunar podiatry unit in left handed operator configuration.

## DRAWERS' INTERNAL INSERTS

<b>T1</b>	 without partitions	 4 partitions	 tools' holder	 8 partitions	 16 partitions
<b>T2</b>	 2 partitions	 6 partitions	 without partitions		
<b>T3</b>	 2 partitions	 6 partitions	 without partitions		

**Option:**  
front panel's drawers painted in a color  
of your choice from Stern Podia selection.

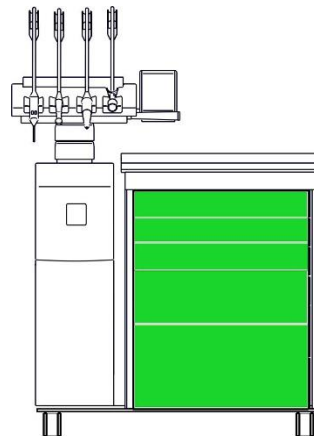

### Matte colors



### Bright colors

