

OPERATING UNIT **ATLAS**

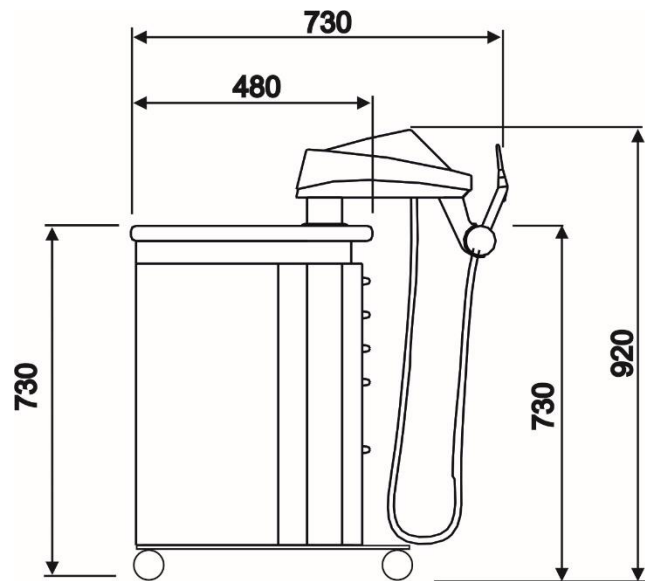
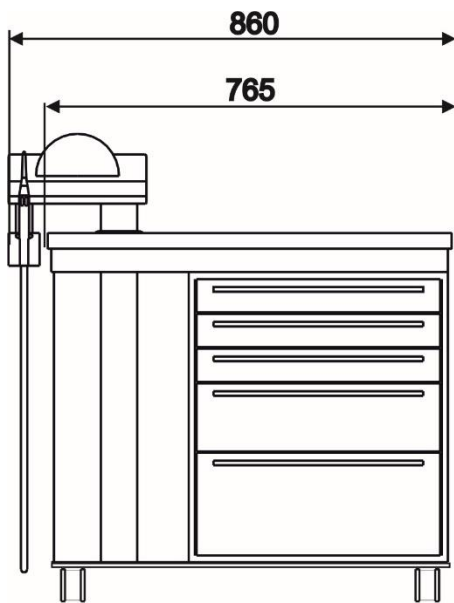

Technical characteristics

- Operating voltage: 24 V
- Air: 5 bar, 50 l/min
- Power supply: 230 v/115 v, 250 W
- Weight: 80 Kg

CHEST OF DRAWERS' CONFIGURATION



WITHOUT HANDLES

Drawers mounted on "push" slides that allow the opening of the drawer with a slight pressure on the front panel.



WHITE HANDLES

Drawers mounted on soft closing slides and equipped with a newly designed aluminum handle painted in white.



COLORED HANDLES

Drawers mounted on soft closing slides and equipped with a new design aluminum handle painted in a color of your choice from Stern Podia selection.

TYPE OF DRAWERS (T1/T2/T3) AND DOORS (T5/T8):

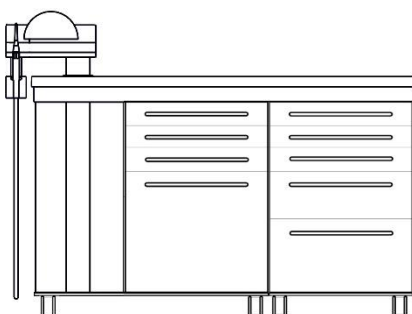
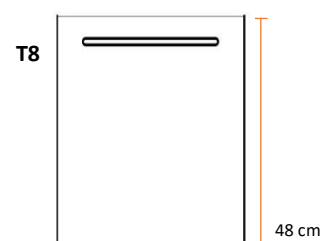
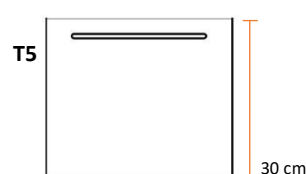



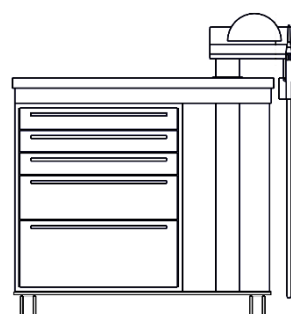







Possibility to configure the podiatric unit with an additional chest of drawers.



Possibility to order the Atlas podiatry unit in left handed operator configuration.

DRAWERS' INTERNAL INSERTS

T1	 without partitions	 4 partitions	 tools' holder	 8 partitions	 16 partitions
T2	 2 partitions	 6 partitions	 without partitions		
T3	 2 partitions	 6 partitions	 without partitions		

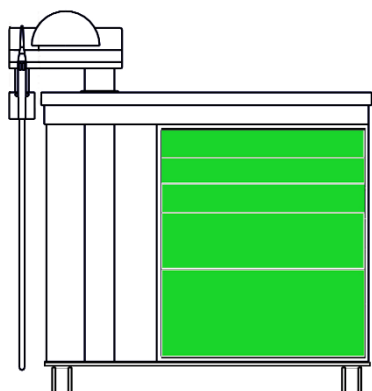

Option:
front panel's drawers painted in a color
of your choice from Stern Podia selection.

Matte colors



Bright colors

